

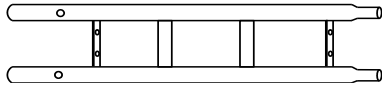

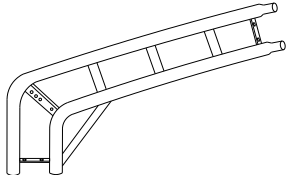
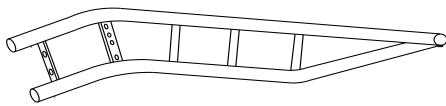
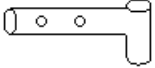
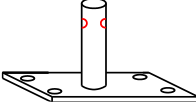
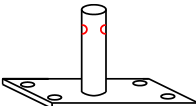
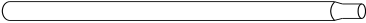
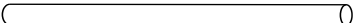
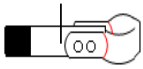
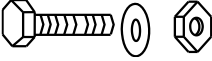
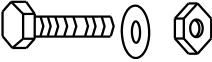

# PARTS LIST FOR SH-BC1220

(No.: 2017.3)

Parts	Descriptions	Diagram	Dimensions in mm	Q'TY
1	Vertical leg		38x1545	4
2	Rear arm		38x2020	4
3	Front arm		38x2090	4
4	Support Tube		25x110	4
5	Base plate *see step 1		8x100x300	4
6	Base plate *see step 1		8x100x300	4
7	Purlin		25x2070	10
8	Purlin		25x2070	5
9	Support Clamp		25	4
10	Bolt for arms and supports		M8x80	32
11	Bolt for plates		M8x60	8
12	Ratchet strap		T-2	18
13	Fabric Cover			1
14	Lock Washer		Note: Must be used on all bolts	40

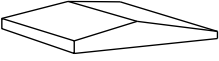
**L – 20 ft x W – 12 ft  
FRAME DIAGRAM**

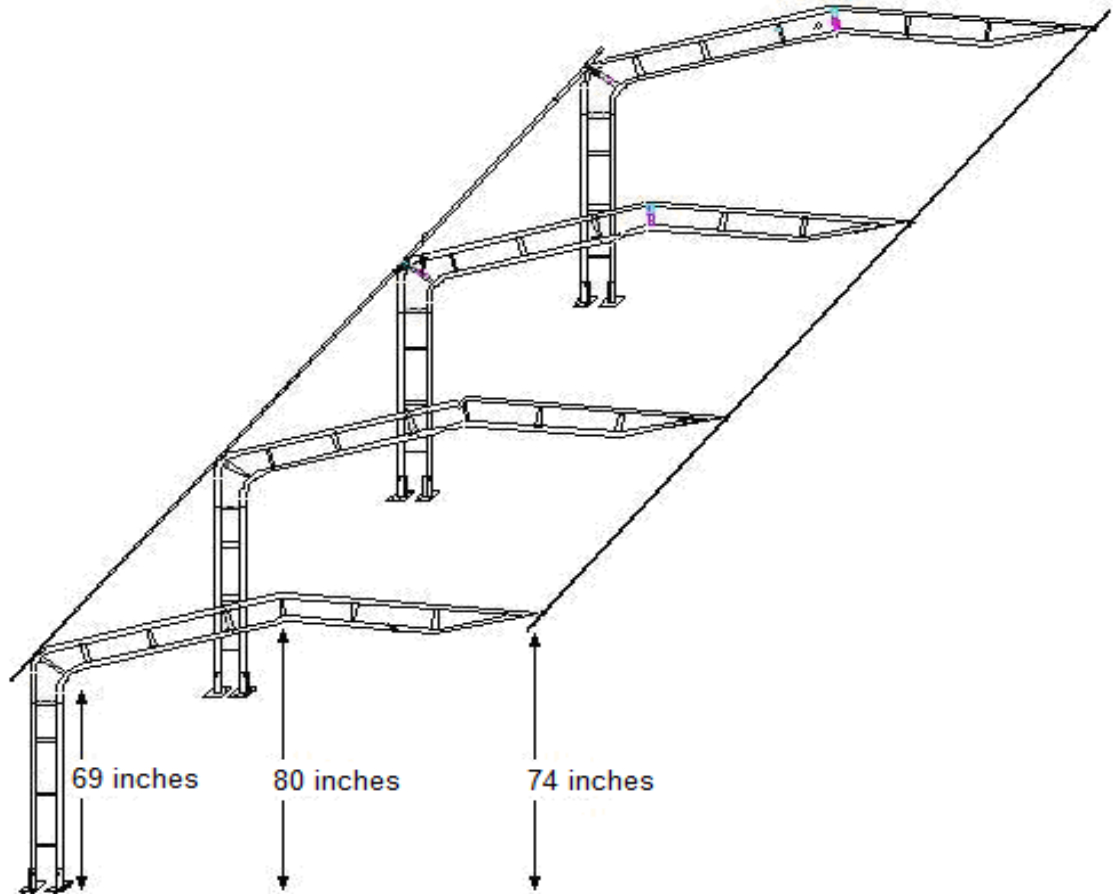

**WARNING:**

**DOCK MUST BE ANCHORED SECURELY AND  
WEIGHTED SUFFICIENTLY ENOUGH TO WITHSTAND  
THE FORCES OF WINDS AGAINST THE CANOPY**

**STEP 1:** Fix the base plates #5 and #6 on the dock.

Measurements for reference purposes only, adjust arm location to suit dock conditions.

Use vertical legs 1 for proper spacing of base plates.

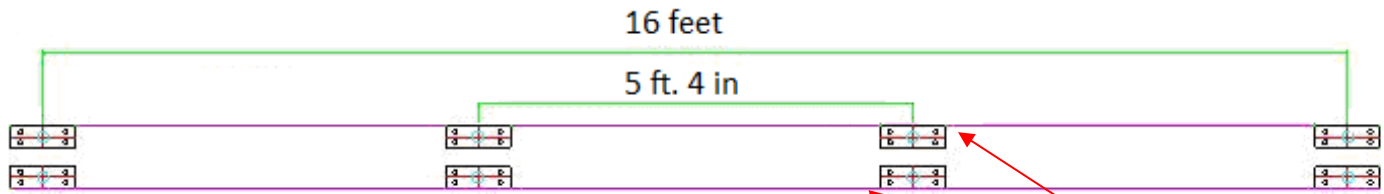

Part #6

Part #5

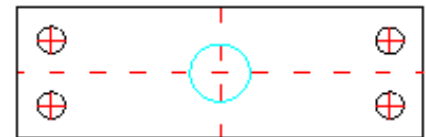
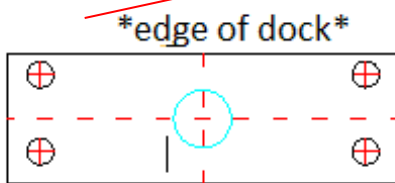

Base-Plate with holes closest to edge to

be mounted on dock edge closest to water.

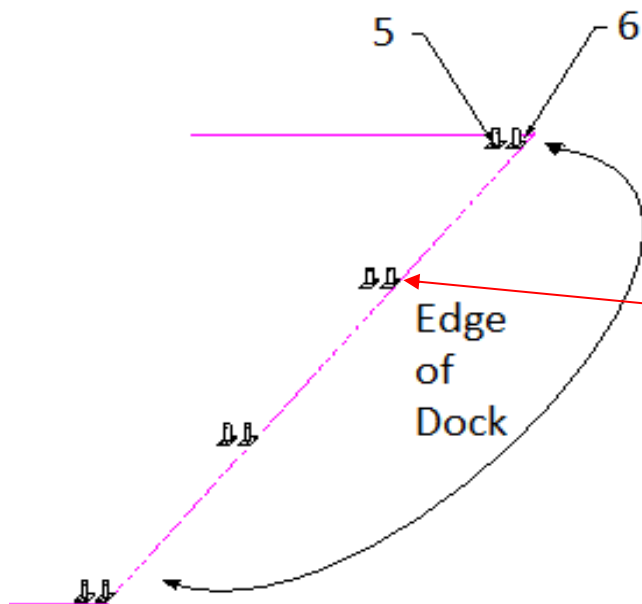

**\*WARNING\***

**ARMS MUST BE SUPPORTED BY AT LEAST**

**3/8" x 3 1/2" GALVANIZED LAG BOLTS**

**EXTRA SUPPORT MUST BE INSTALLED BELOW DECK BOARDS**

**STEP 2:** Insert the vertical legs #1 into the base plates, fixing them with bolts #11.

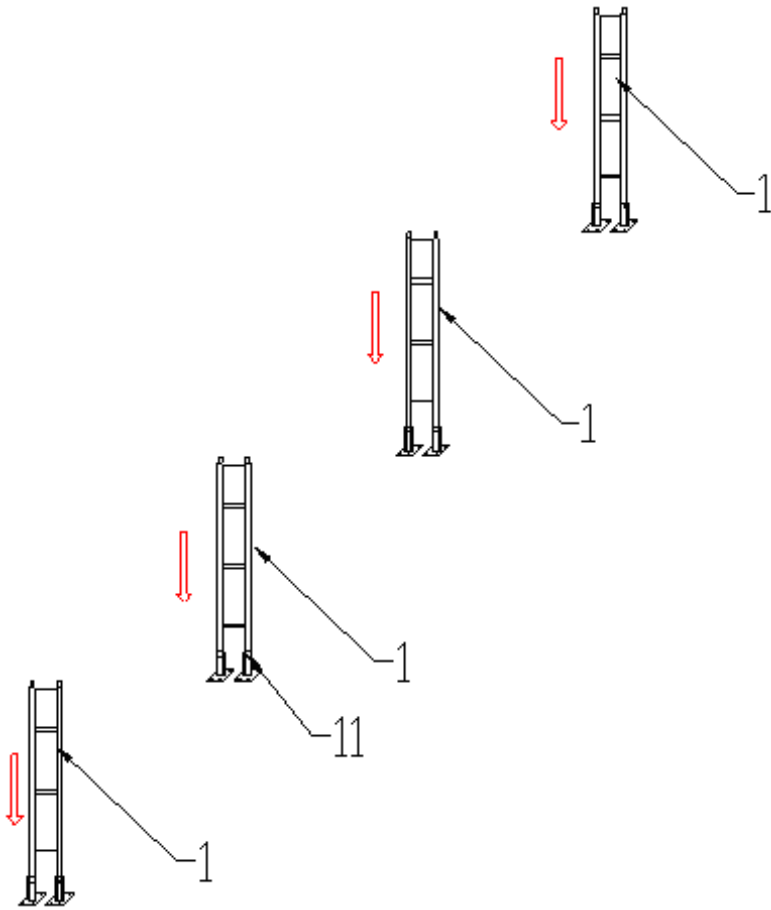

**STEP 3:** Assemble the rear arms #2 and front arms #3, fixing them with the bolts #10.

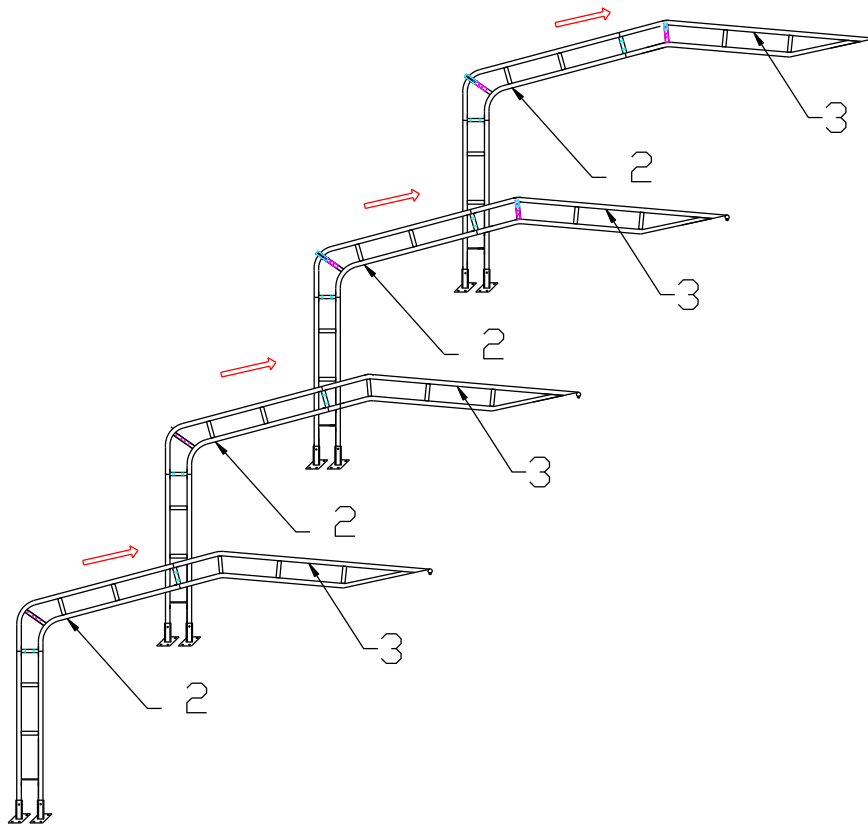

**STEP 4:** Fix clamp #9 and support tube #4 with the bolts #10. Bolts on support tubes must remain

loose until the purlins are installed. Put the purlins (rods) #7 and #8 into support tube #4 and the clamps and tighten bolts.

**For Black Fabric:** Install center perlines into clamps as well.

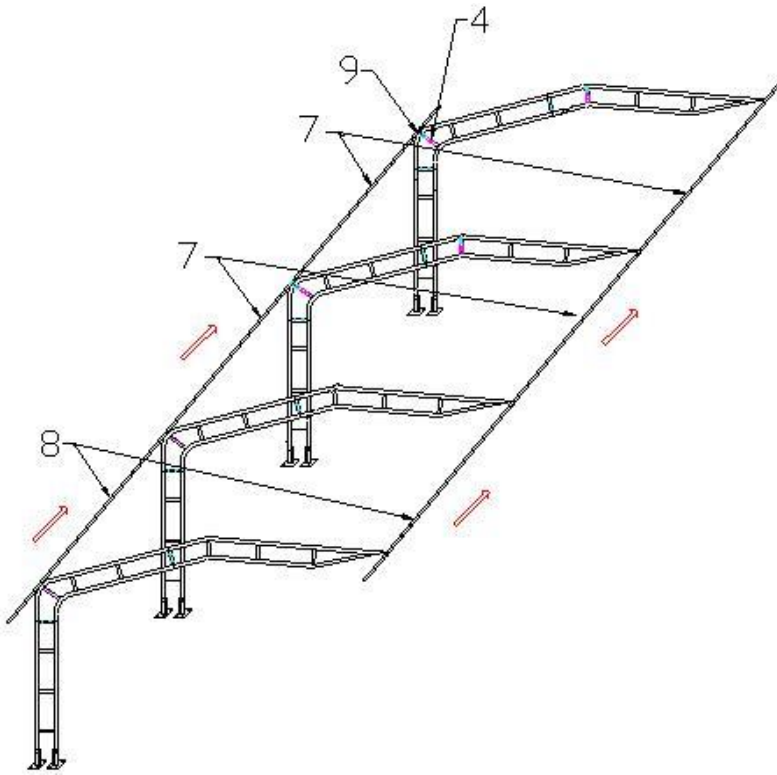

**STEP 5:**

Connect the purlins with each other, insert them into the pockets of the cover.

**Note:** Purlins (rods) with long stoppers are *outside* purlins

Purlins(rods) with short stoppers are *center* purlins (blue and green fabric only)



**STEP 6:** Place canopy with purlins (rods) on top of the frame. Attach Velcro straps to rod on dock side. Pull canopy over and install ratchet straps. Tighten center rod to clamps



**For Blue and Green Fabrics only:**

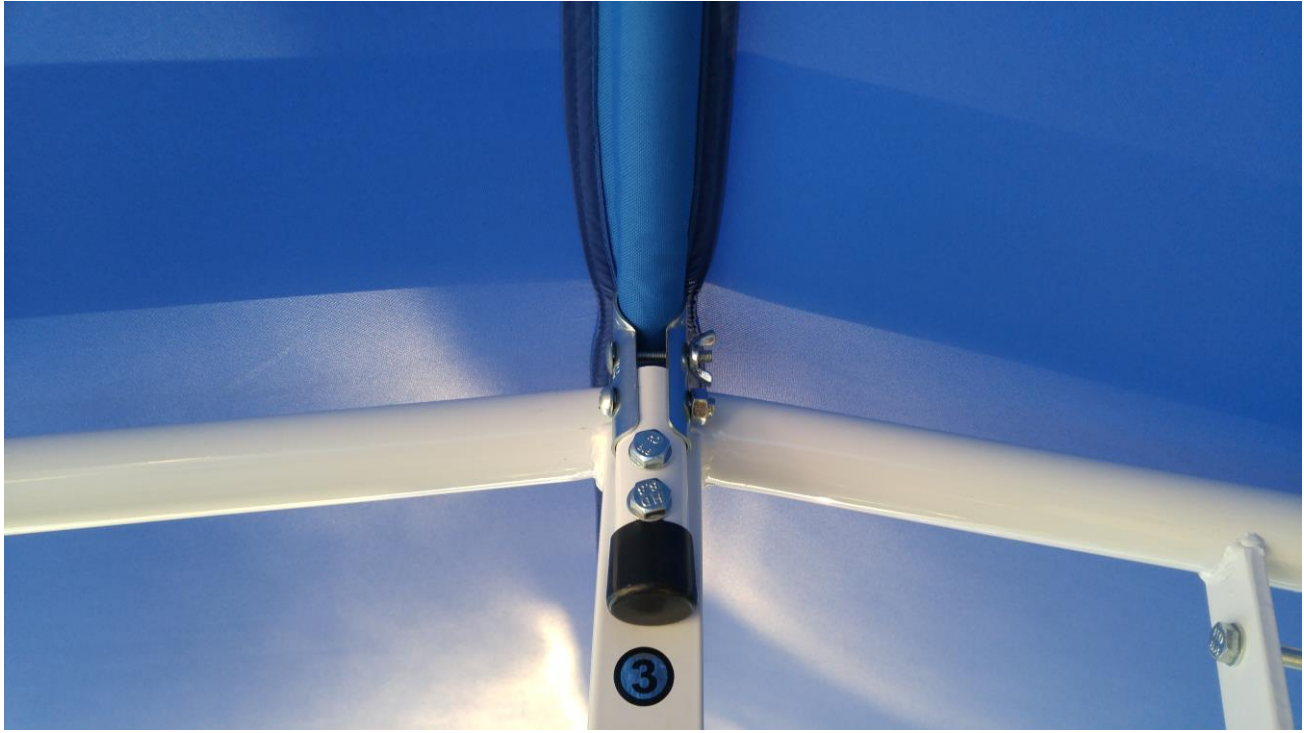

**For Black Fabrics only:**



**STEP 7:** Tighten purlins #7 and #8 with ratchet straps #12

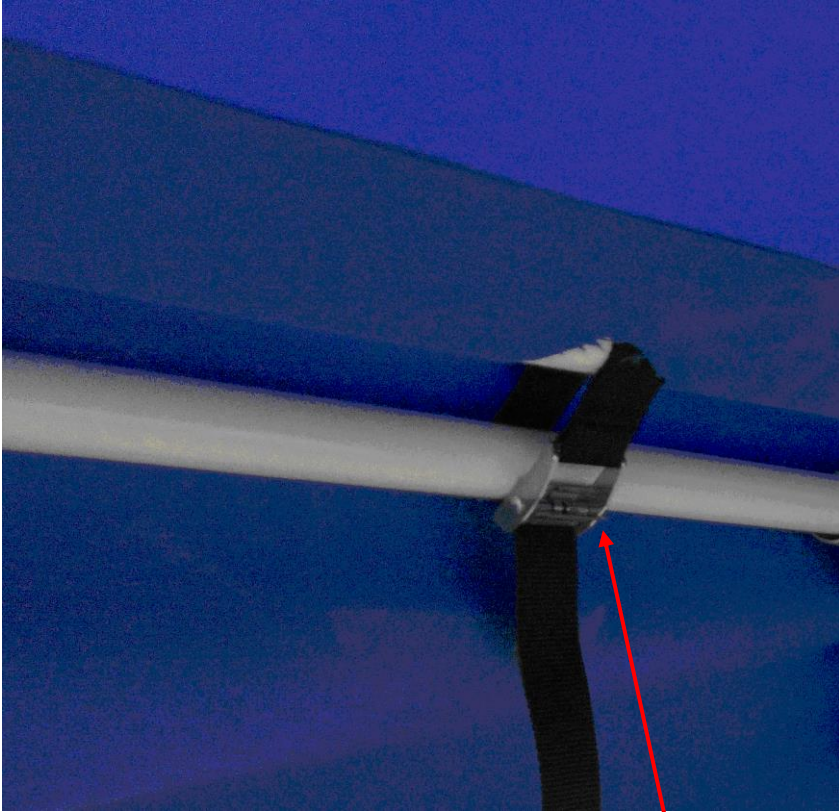

**\*Canopy straps & bolts must be retightened after 2-3 days!\***

Over time, canopy frame may require maintenance with additional rust-proof paint